

PROTRON ECLYPSE™

user manual

ELATION | PROTRON ECLYPSE | user manual

©2018 ELATION PROFESSIONAL all rights reserved. Information, specifications, diagrams, images, and instructions herein are subject to change without notice. ELATION PROFESSIONAL logo and identifying product names and numbers herein are trademarks of ELATION PROFESSIONAL. Copyright protection claimed includes all forms and matters of copyrightable materials and information now allowed by statutory or judicial law or hereinafter granted. Product names used in this document may be trademarks or registered trademarks of their respective companies and are hereby acknowledged. All non-ELATION brands and product names are trademarks or registered trademarks of their respective companies.

ELATION PROFESSIONAL and all affiliated companies hereby disclaim any and all liabilities for property, equipment, building, and electrical damages, injuries to any persons, and direct or indirect economic loss associated with the use or reliance of any information contained within this document, and/or as a result of the improper, unsafe, insufficient and negligent assembly, installation, rigging, and operation of this product.

Elation Professional USA | 6122 S. Eastern Ave. | Los Angeles, CA. 90040
 323-582-3322 | 323-832-9142 fax | www.elationlighting.com | info@elationlighting.com

Elation Professional B.V. | Junostraat 2 | 6468 EW Kerkrade, The Netherlands
 +31 45 546 85 66 | +31 45 546 85 96 fax | www.elationlighting.eu | info@elationlighting.eu

Elation Professional Mexico | AV Santa Ana 30 | Parque Industrial Lerma, Lerma, Mexico 52000
 +52 (728) 282-7070

D O C U M E N T V E R S I O N

Due to additional product features and/or enhancements, an updated version of this document may be available online.

Please check www.elationlighting.com for the latest revision/update of this manual, before beginning installation and/or programming.

Date	Document Version	Software Version ≥	DMX Channel Modes	Notes
11/16/18	1	1.1	57	Initial preliminary release.
01/23/19	1.2	N/C	NO CHANGE	Updated Hour Average LED Life Spec
01/24/19	1.4	N/C	24	Updated specs.
11/10/20	1.6	1.5	NO CHANGE	Updated specs.

CONTENTS

General Information	4
Limited Warranty (USA Only)	5
Safety Guidelines	6
Maintenance Guidelines	8
Fixture Overview	9
Installation Guidelines	10
System Menu	18
Pixel Zone Control	20
DMX Channel Functions and Values	21
Specifications	24
Optional Accessories	26

GENERAL INFORMATION

INTRODUCTION

Please read and understand the instructions in this manual carefully and thoroughly before attempting to operate this device. These instructions contain important safety and use information.

UNPACKING

Every device has been thoroughly tested and has been shipped in perfect operating condition. Carefully check the shipping carton for damage that may have occurred during shipping. If the carton is damaged, carefully inspect the device for damage, and be sure all accessories necessary to install and operate the device have arrived intact. In the event damage has been found or parts are missing, please contact our customer support team for further instructions. Please do not return this device to your dealer without first contacting customer support. Please do not discard the shipping carton in the trash. Please recycle whenever possible.

BOX CONTENTS

- (1) Omega Bracket
- (1) IP65 Twist-Lock Power Cable

CUSTOMER SUPPORT

Contact ELATION Service for any product related service and support needs. Also visit forums.elationlighting.com with questions, comments or suggestions.

ELATION SERVICE USA - Monday - Friday 8:00am to 4:30pm PST
323-582-3322 | Fax 323-832-9142 | support@elationlighting.com

ELATION SERVICE EUROPE - Monday - Friday 08:30 to 17:00 CET
+31 45 546 85 63 | Fax +31 45 546 85 96 | support@elationlighting.eu

REPLACEMENT PARTS please visit parts.elationlighting.com



I M P O R T A N T N O T I C E !

THERE ARE NO USER SERVICEABLE PARTS INSIDE THIS UNIT. DO NOT ATTEMPT ANY REPAIRS YOURSELF; DOING SO WILL VOID YOUR MANUFACTURES WARRANTY. DAMAGES RESULTING FROM MODIFICATIONS TO THIS FIXTURE AND/OR THE DISREGARD OF SAFETY INSTRUCTIONS AND GUIDELINES IN THIS MANUAL VOID THE MANUFACTURES WARRANTY AND ARE NOT SUBJECT TO ANY WARRANTY CLAIMS AND/OR REPAIRS.

LIMITED WARRANTY (USA ONLY)

- A. Elation Professional hereby warrants, to the original purchaser, Elation Professional products to be free of manufacturing defects in material and workmanship for a period of two years (730 days), and Elation Professional product rechargeable batteries to be free of manufacturing defects in material and workmanship for a period of six months (180 days), from the original date of purchase. This warranty excludes discharge lamps and all product accessories. This warranty shall be valid only if the product is purchased within the United States of America, including possessions and territories. It is the owner's responsibility to establish the date and place of purchase by acceptable evidence, at the time service is sought.
- B. For warranty service, send the product only to the Elation Professional factory. All shipping charges must be pre-paid. If the requested repairs or service (including parts replacement) are within the terms of this warranty, Elation Professional will pay return shipping charges only to a designated point within the United States. If any product is sent, it must be shipped in its original package and packaging material. No accessories should be shipped with the product. If any accessories are shipped with the product, Elation Professional shall have no liability whatsoever for loss and/or or damage to any such accessories, nor for the safe return thereof.
- C. This warranty is void if the product serial number and/or labels are altered or removed; if the product is modified in any manner which Elation Professional concludes, after inspection, affects the reliability of the product; if the product has been repaired or serviced by anyone other than the Elation Professional factory unless prior written authorization was issued to purchaser by Elation Professional; if the product is damaged because not properly maintained as set forth in the product instructions, guidelines and/or user manual.
- D. This is not a service contract, and this warranty does not include any maintenance, cleaning or periodic check-up. During the periods as specified above, Elation Professional will replace defective parts at its expense, and will absorb all expenses for warranty service and repair labor by reason of defects in material or workmanship. The sole responsibility of Elation Professional under this warranty shall be limited to the repair of the product, or replacement thereof, including parts, at the sole discretion of Elation Professional. All products covered by this warranty were manufactured after January 1, 1990, and bare identifying marks to that effect.
- E. Elation Professional reserves the right to make changes in design and/or performance improvements upon its products without any obligation to include these changes in any products theretofore manufactured.
- F. No warranty, whether expressed or implied, is given or made with respect to any accessory supplied with the products described above. Except to the extent prohibited by applicable law, all implied warranties made by Elation Professional in connection with this product, including warranties of merchantability or fitness, are limited in duration to the warranty periods set forth above. And no warranties, whether expressed or implied, including warranties of merchantability or fitness, shall apply to this product after said periods have expired. The consumer's and/or dealer's sole remedy shall be such repair or replacement as is expressly provided above; and under no circumstances shall Elation Professional be liable for any loss and/or damage, direct and/or consequential, arising out of the use of, and/or the inability to use, this product.
- G. This warranty is the only written warranty applicable to Elation Professional products and supersedes all prior warranties and written descriptions of warranty terms and conditions heretofore published.

WARRANTY RETURNS

All returned service items whether under warranty or not, must be freight pre-paid and accompany a return authorization (R.A.) number. The R.A. number must be clearly written on the outside of the return package. A brief description of the problem as well as the R.A. number must also be written down on a piece of paper and included in the shipping container. If the unit is under warranty, you must provide a copy of your proof of purchase invoice. Items returned without a R.A. number clearly marked on the outside of the package will be refused and returned at customer's expense. You may obtain a R.A. number by contacting customer support.

SAFETY GUIDELINES

This fixture is a sophisticated piece of electronic equipment. To guarantee a smooth operation, it is important to follow all instructions and guidelines in this manual. Elation Professional is not responsible for injury and/or damages resulting from the misuse of this fixture due to the disregard of the information printed in this manual. Only qualified and/or certified personnel should perform installation of this fixture and only the original rigging parts (omega brackets) included with this fixture should be used for installation. Any modifications to the fixture and/or the included mounting hardware will void the original manufactures warranty and increase the risk of damage and/or personal injury.



PROTECTION CLASS 1 - FIXTURE MUST BE PROPERLY GROUNDED



**THERE ARE NO USER SERVICEABLE PARTS INSIDE THIS UNIT.
DO NOT ATTEMPT ANY REPAIRS YOURSELF; DOING SO WILL VOID YOUR
MANUFACTURES WARRANTY. DAMAGES RESULTING FROM
MODIFICATIONS TO THIS FIXTURE AND/OR THE DISREGARD OF SAFETY
INSTRUCTIONS AND GUIDELINES IN THIS MANUAL VOID THE
MANUFACTURES WARRANTY AND ARE NOT SUBJECT TO ANY
WARRANTY CLAIMS AND/OR REPAIRS.**



**DO NOT PLUG FIXTURE INTO A DIMMER PACK!
NEVER OPEN THIS FIXTURE WHILE IN USE!
UNPLUG POWER BEFORE SERVICING FIXTURE!
NEVER TOUCH FIXTURE DURING OPERATION, AS IT MAY BE HOT!
KEEP FLAMMABLE MATERIALS AWAY FROM FIXTURE!**



**ENSURE ALL CONNECTIONS AND END CAPS ARE PROPERLY SEALED
WITH A DIELECTRIC GREASE (AVAILABLE AT MOST ELECTRICAL
SUPPLIERS) TO PREVENT WATER CORROSION AND/OR ELECTRICAL
SHORT CIRCUIT.**



**NEVER LOOK DIRECTLY INTO THE LIGHT SOURCE!
RETINA INJURY RISK - MAY INDUCE BLINDNESS!
SENSITIVE PERSONS MAY SUFFER AN EPILEPTIC SHOCK!**

S A F E T Y G U I D E L I N E S

DO NOT TOUCH the fixture housing during operation. Turn OFF the power and allow approximately 15 minutes for the fixture to cool down before serving.

DO NOT shake fixture, avoid brute force when installing and/or operating fixture.

DO NOT operate fixture if the power cord is frayed, crimped, damaged and/or if any of the power cord connectors are damaged and do not insert into the fixture securely with ease.

NEVER force a power cord connector into the fixture. If the power cord or any of its connectors are damaged, replace it immediately with a new one of similar power rating.

DO NOT block any air ventilation slots.

All fan and air inlets must remain clean and never blocked.

Allow approx. 6" (15cm) between fixture and other devices or a wall for proper cooling.

When installing fixture in a suspended environment, always use mounting hardware that is no less than M10 x 25 mm, and always install fixture with an appropriately rated safety cable.

Always disconnect fixture from main power source before performing any type of service and/or cleaning procedure. Only handle the power cord by the plug end, never pull out the plug by tugging the wire portion of the cord.

During the initial operation of this fixture, a light smoke or smell may emit from the interior of the fixture. This is a normal process and is caused by excess paint in the interior of the casing burning off from the heat associated with the lamp and will decrease gradually over time.

Consistent operational breaks will ensure fixture will function properly for many years.

ONLY use the original packaging and materials to transport the fixture in for service.

MAINTENANCE GUIDELINES



DISCONNECT POWER BEFORE PERFORMING ANY MAINTENANCE!

CLEANING

Frequent cleaning is recommended to insure proper function, optimized light output, and an extended life. The frequency of cleaning depends on the environment in which the fixture operates: damp, smoky or particularly dirty environments can cause greater accumulation of dirt on the fixture's optics. Clean the external lens surface at least every 20 days with a soft cloth to avoid dirt/debris accumulation.

NEVER use alcohol, solvents, or ammonia-based cleaners.

MAINTENANCE

Regular inspections are recommended to insure proper function and extended life.

There are no user serviceable parts inside this fixture, please refer all other service issues to an authorized Elation service technician. Should you need any spare parts, please order genuine parts from your local Elation dealer.

Please refer to the following points during routine inspections:

A detailed electric check by an approved electrical engineer every three months, to make sure the circuit contacts are in good condition and prevent overheating.

Be sure all screws and fasteners are always tightened securely. Loose screws may fall out during normal operation resulting in damage or injury as larger parts could fall.

Check for any deformations on the housing, color lenses, rigging hardware and rigging points (ceiling, suspension, trussing). Deformations in the housing could allow for dust to enter the fixture. Damaged rigging points or unsecured rigging could cause the fixture to fall and seriously injure a person(s).

Electric power supply cables must not show any damage, material fatigue or sediments.

NEVER remove the ground prong from the power cable.

FIXTURE OVERVIEW

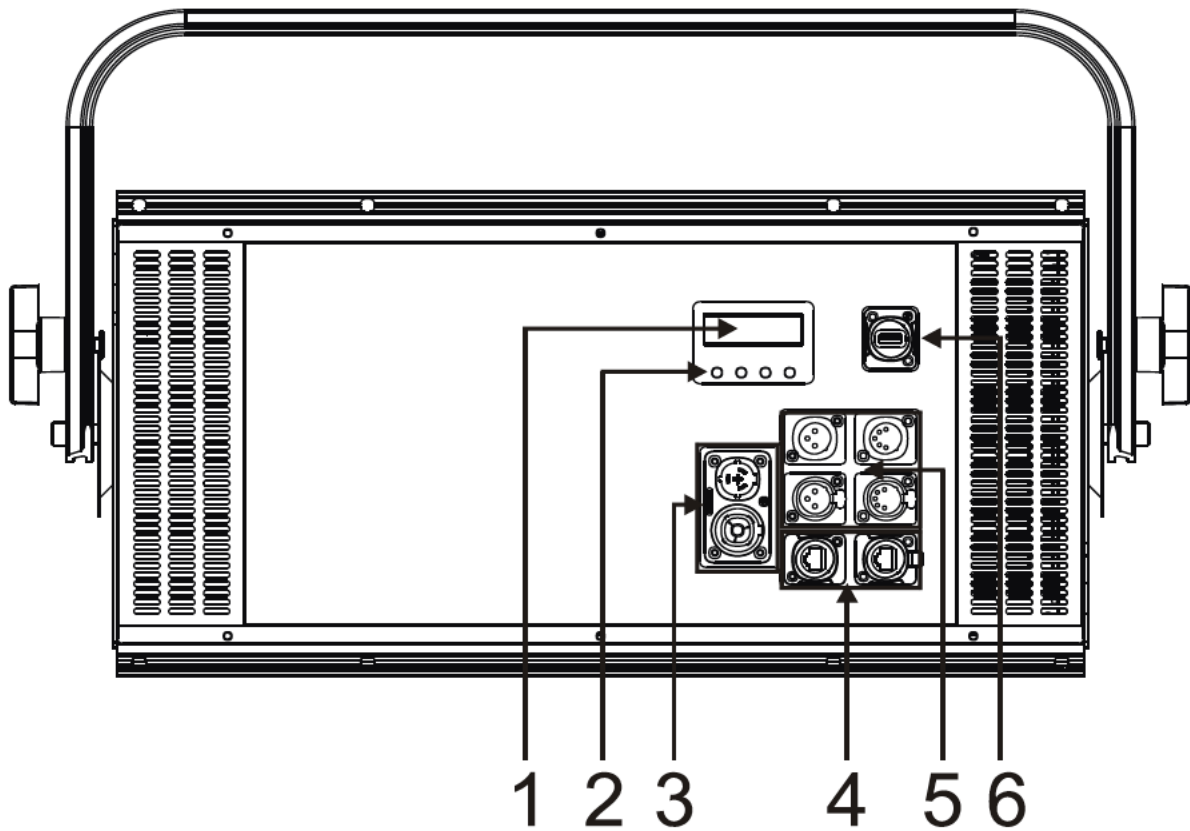

1. OLED Control Menu Display
2. MENU, DOWN, UP, ENTER Buttons
3. IP65 Locking Power IN/OUT
4. IP65 RJ45 IN/OUT
5. IP65 Locking 3pin/5pin DMX IN/OUT

INSTALLATION GUIDELINES

IPX4 RATED

An IP rated lighting fixture is one, which is commonly installed in outdoor environments and has been designed with an enclosure that effectively protects the ingress (entry) of external foreign objects such as dust and water. The **International Protection (IP)** rating system is commonly expressed as "**IP**" (Ingress Protection) followed by two numbers (i.e. IP20) where the numbers define the degree of protection. The first digit (Foreign Bodies Protection) indicates the extent of protection against particles entering the fixture and the second digit (Water Protection) indicates the extent of protection against water entering the fixture.

An **IPX4** rated lighting fixture designed for temporary outdoor environments which has NOT been tested to protect against the ingress of dust (**X**) but has been tested to protect from splash of water in any direction (**4**).

PERMANENT OUTDOOR AND/OR MARINE/COSTAL INSTALLATIONS

Please note although this fixture is IP rated, this fixture is **NOT** suitable for permanent outdoor and/or marine environment installations. Installing this fixture in permanent outdoor and/or marine environment installation may cause corrosion and/or excessive wear to the interior and/or exterior components of the fixture. Damages and/or performance issues resulting from installation in a permanent outdoor and/or marine environment installation will void the manufactures warranty and will **NOT** be subject to any warranty claims and/or repairs.



FLAMMABLE MATERIAL WARNING

Keep fixture minimum 5.0 feet (1.5m) away from flammable materials and/or pyrotechnics.



ELECTRICAL CONNECTIONS

A qualified electrician should be used for all electrical connections and/or installations.



ENSURE ALL CONNECTIONS AND END CAPS ARE PROPERLY SEALED WITH A NON-CONDUCTIVE DIELECTRIC GREASE (AVAILABLE AT MOST ELECTRICAL SUPPLIERS) TO PREVENT WATER INGRESS/CONDENSATION AND/OR CORROSION.



USE CAUTION WHEN POWER LINKING OTHER MODEL FIXTURES AS THE POWER CONSUMPTION OF OTHER MODEL FIXTURES MAY EXCEED THE MAX POWER OUTPUT ON THIS FIXTURE. CHECK SILK SCREEN FOR MAX AMPS.

INSTALLATION GUIDELINES



DO NOT INSTALL THE FIXTURE IF YOU ARE NOT QUALIFIED TO DO SO!

Fixture **MUST** be installed following all local, national, and country commercial electrical and construction codes and regulations.

Before rigging/mounting a single fixture or multiple interconnected fixtures for custom matrix designs to any metal truss/structure or placing the fixture(s) on any surface, a professional equipment installer **MUST** be consulted to determine if the metal truss/structure or surface is properly certified to safely hold the combined weight of the fixture(s), clamps, cables, and accessories.

Fixture ambient operating temperature range is **14° to 113°F. (-10° to 45°C)**

Do not use the fixture under or above this temperature.

Fixture(s) should be installed in areas outside walking paths, seating areas, or away from areas where unauthorized personnel might reach the fixture by hand.

NEVER stand directly below the fixture(s) when rigging, removing or servicing.

Overhead fixture installation must always be secured with a secondary safety attachment, such as an appropriately rated safety cable that meets all local, national, and country codes and regulations. Allow approximately 15 minutes for the fixture to cool down before serving.



TO MAINTAIN IPX4 RATING INTEGRITY AND PREVENT WATER FROM ENTERING FIXTURE, ALL UNUSED CONNECTION RUBBER CAPS MUST BE SEALED.



SEAL ALL UNUSED CONNECTIONCAPS

INSTALLATION GUIDELINES

CLAMP MOUNTING

The adjustable yoke bracket attached to the fixture includes 3-position holes for versatile fixture positioning. Depending on rigging position of the fixture, it may be best to use more than one clamp attached to the yoke. The included Omega Bracket can be attached to the fixture for easy clamp rigging. When mounting this fixture to truss or a metal structure, be sure to secure an appropriately rated clamp (not included) using an M10 screw.



WHEN USING THE ADJUSTABLE YOKE TO MOUNT THE FIXTURE, MAKE SURE BOTH YOKE HANDLE KNOBS ARE SECURE BEFORE RIGGING FIXTURE! USE AN APPROPRIATELY RATED CLAMP (NOT INCLUDED) USING AN M10 SCREW!

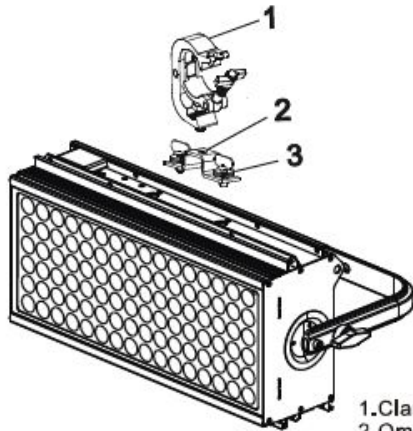

- 1. Clamp
- 2. Omega-holders
- 3. Quick-lock fastener

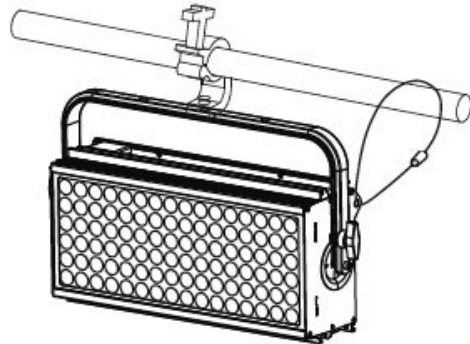

SAFETY CABLE Fixture includes 2 integrated safety cable rigging points. (see below)



ALWAYS ATTACH AN APPROPRIATELY RATED SAFETY CABLE (NOT INCLUDED) THAT MEETS ALL LOCAL, NATIONAL, AND COUNTRY CODES AND REGULATIONS WHENEVER INSTALLING FIXTURE IN A SUSPENDED ENVIRONMENT!



INSTALLATION GUIDELINES

LINKING FIXTURES

The fixture includes integrated spring-loaded locking pins which are used to connect multiple fixtures together horizontally and vertically to create seamless custom matrix designs. See below for fixture linking steps.



**EACH FIXTURE MUST BE SECURED WITH ITS OWN SAFETY CABLE!
USE AN APPROPRIATELY RATED SAFETY CABLE (NOT INCLUDED) THAT
MEETS ALL LOCAL, NATIONAL, AND COUNTRY CODES AND REGULATIONS.**

OVERHEAD RIGGING

Overhead rigging requires extensive experience, including amongst others calculating working load limits, installation material being used, and periodic safety inspection of all installation material and the fixture. If you lack these qualifications, do not attempt the installation yourself. Improper installation can result in bodily injury and property damage.

Spring-Loaded Locking-Pins

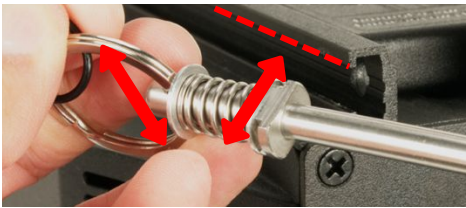

1. The spring-loaded locking-pin has a stepped rail-block with two flat surfaces that, when horizontally aligned with the rail, allow it to pass through (Notice that the ring orientation and the flat surfaces of the stepped rail-block are perpendicular to each other).

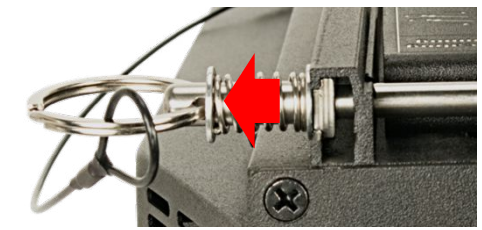

2. Compress spring and turn locking-pin 90° (either direction) to lock pin into the rail. As the rail-block of the spring-loaded locking-pin is stepped, it will snap the lock into place in a horizontal orientation.

INSTALLATION GUIDELINES

Horizontal Fixture Linking

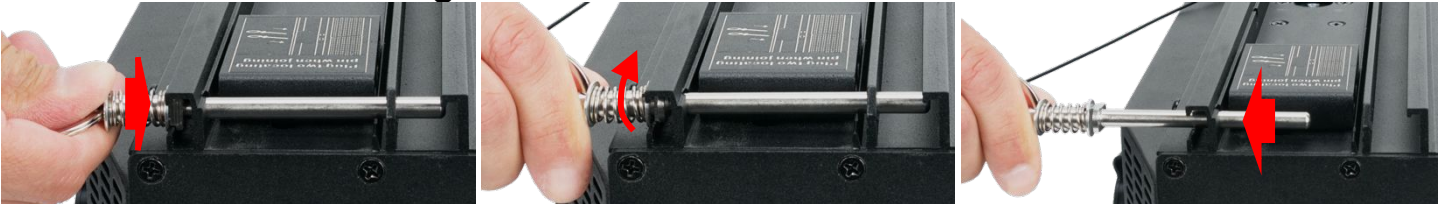

- 1 . Remove spring-loaded locking-pin, compress the spring enough to clear the rail, rotate ring to vertical orientation (stepped rail-block to a horizontal orientation), and pull it straight out.



- 2 . To horizontally secure two adjacent fixtures, each fixture has an integrated locking-pin abutment-block that is activated to bridge and secure the adjoining unit.

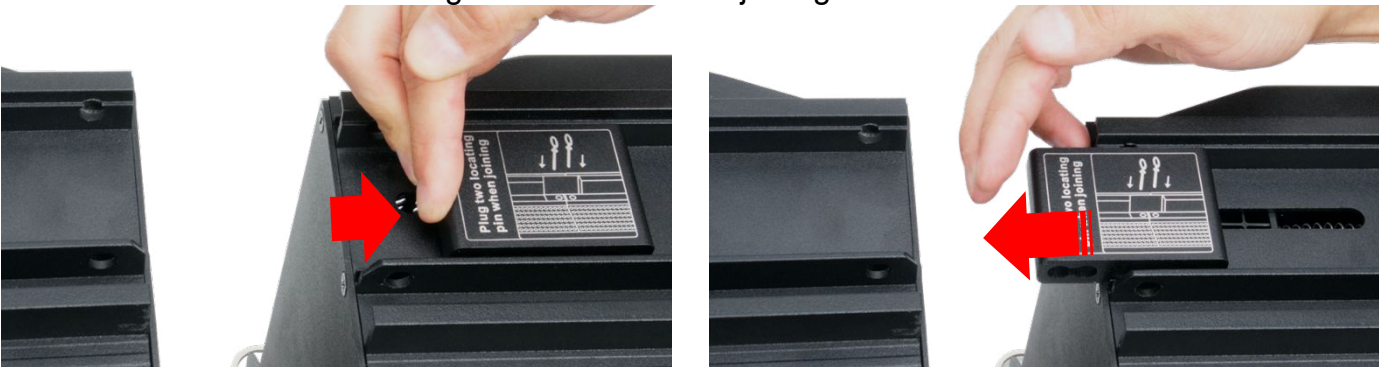

3. Press-click the locking-pin abutment block to release the spring-loaded locking mechanism; this will pop the abutment-block out towards the adjacent fixture.

INSTALLATION GUIDELINES

Horizontal Fixture Linking

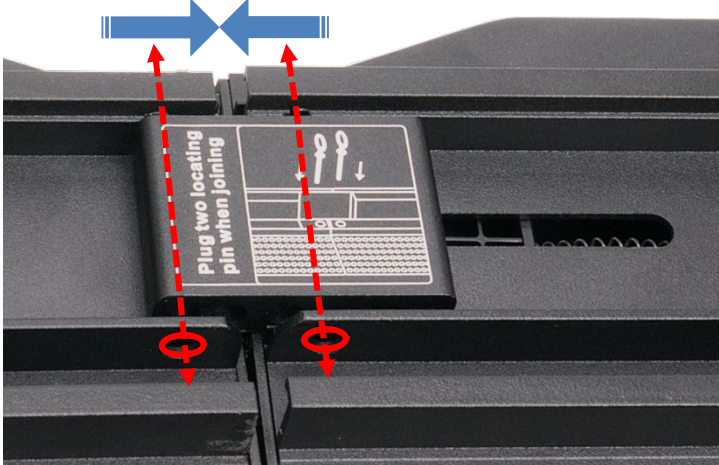

4. With both fixtures horizontally adjoined, align the locking-pin rail holes with the holes in the locking-pin abutment-block, and insert one locking-pin into the first set of aligned holes.

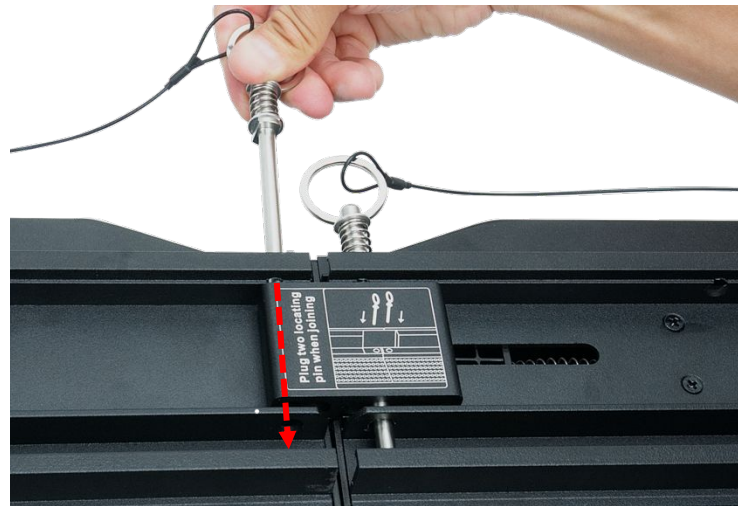

5. Compress the spring of the first locking-pin and rotate the ring 90° to lock it into the rail. Insert and lock a second locking-pin through the second set of aligned holes and ensure that the stepped rail-block of the locking-pin is horizontally aligned with rail slot to pass it through rail slot.



6. Compress the spring of the second locking-pin and rotate the ring 90° to lock it into the rail.

INSTALLATION GUIDELINES

Vertical Fixture Linking

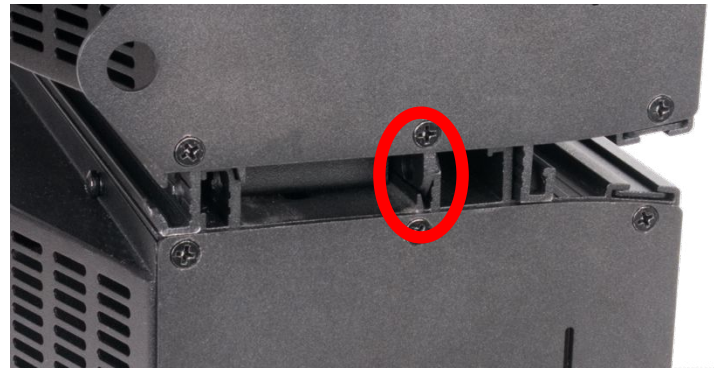
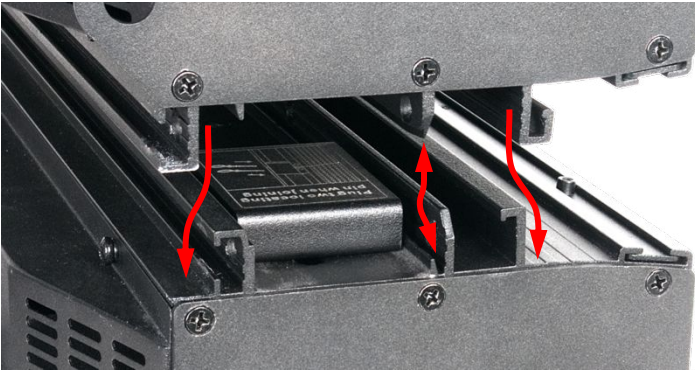

1. To vertically secure two fixtures, each fixture has integrated locking-pin rails at the top and bottom. With both fixtures vertically aligned, the bottom rail straddles the top rail of the bottom unit. Note that the bottom middle rail is stepped and fits into the slot just in back of the middle rail at the top of the bottom unit.

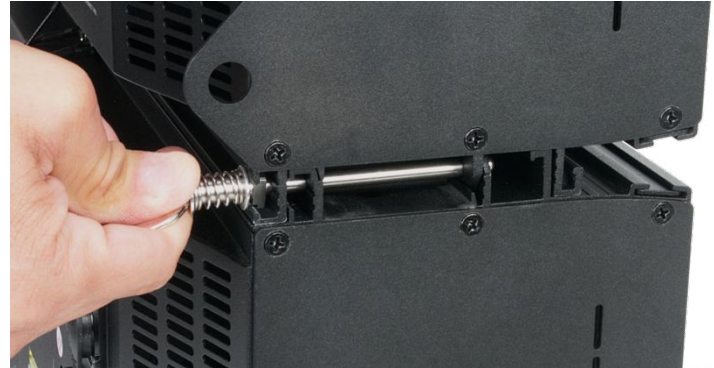
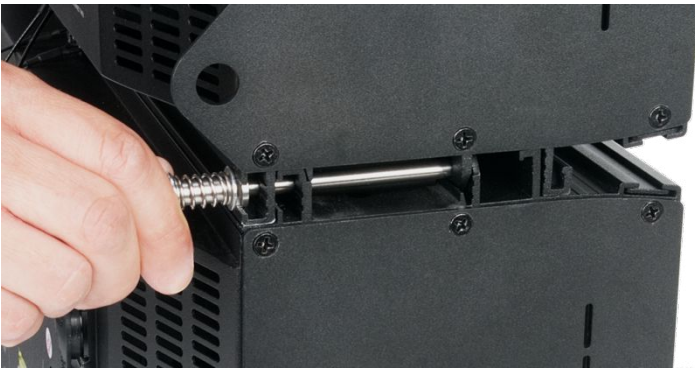

2. With the locking-pin rail holes aligned, insert a locking-pin at each end (compress the spring of the locking-pin and rotate the ring 90° to lock it into the rail).

POWER LINKING



USE CAUTION WHEN POWER LINKING OTHER MODEL FIXTURES AS THE POWER CONSUMPTION OF OTHER MODEL FIXTURES MAY EXCEED THE MAX POWER OUTPUT ON THIS FIXTURE. CHECK SILK SCREEN FOR MAX AMPS.

KLING-NET / ART-NET CONNECTION

When connecting fixture to a network switch to control multiple devices, a **Gigabit Ethernet Switch** that supports **IGMP (Internet Group Management Protocol)** is required. Using a **Gigabit Ethernet Switch** that does not support **IGMP** can cause erratic behavior of all connected devices to the switch. Click link below for more information about IGMP.

https://en.wikipedia.org/wiki/Internet_Group_Management_Protocol

INSTALLATION GUIDELINES

MAXIMUM 5 FIXTURES CAN BE SAFELY LINKED VERTICALLY OR HORIZONTALLY!

NOTE: Illustration below shows optional bracket and clamp. (not included)



**EACH FIXTURE MUST BE SECURED WITH ITS OWN SAFETY CABLE!
USE AN APPROPRIATELY RATED SAFETY CABLE (NOT INCLUDED) THAT
MEETS ALL LOCAL, NATIONAL, AND COUNTRY CODES AND REGULATIONS.**

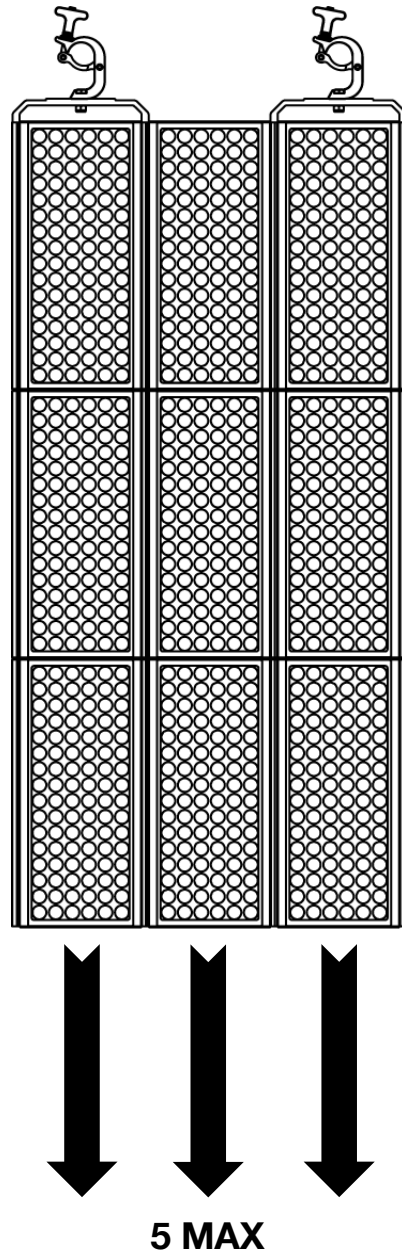
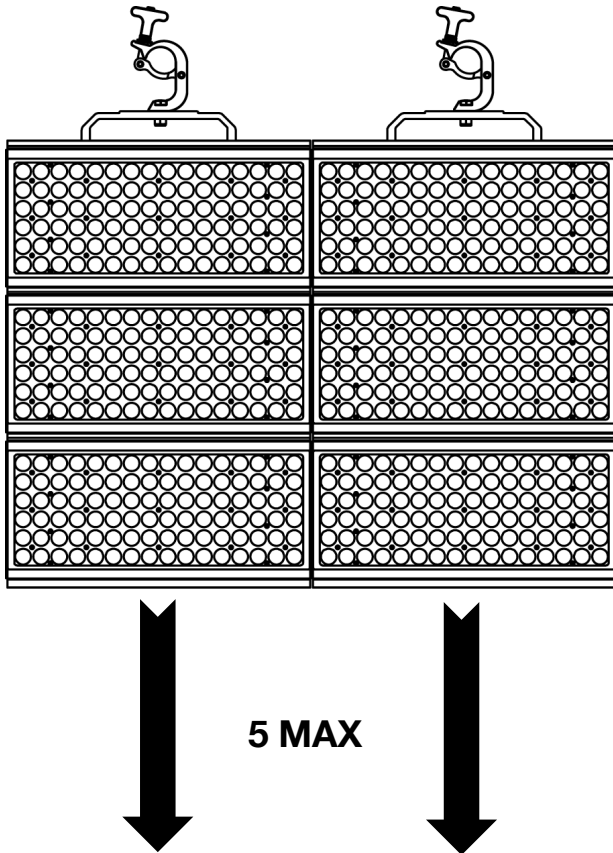

SYSTEM MENU

The fixture includes an easy to navigate system menu where fixture settings can be adjusted via the LCD control panel located on the back of the fixture. (see image below) During normal operation, pressing the **MODE** button once will access the main menu. Navigate through the various sub-menus by pressing the **UP** and **DOWN** buttons, press the **ENTER** button to select a specific sub-menu, press the **UP** and **DOWN** buttons to adjust the selected sub-menu settings, and press the **ENTER** button again to confirm the sub-menu setting selection. Exit the main system menu at any time without making any adjustments by pressing the **MODE** button.

To access the system menu press and hold the **MODE** button for 3 seconds. The LCD Menu Control Display will shut **OFF** automatically about 1 minute from the last button press.

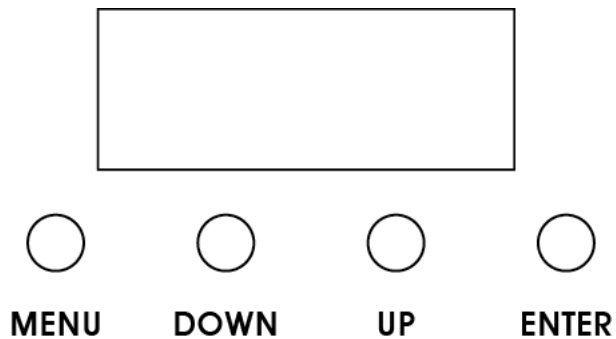

SYSTEM MENU

Supports Software Versions: ≥ A1.5 B1.5

Features are subject to change without any prior written notice.

MENU	SUB MENU	OPTIONS / VALUES (Default Settings in BOLD)	DESCRIPTION	
DMX Setting	DMX Address	001 ~ xxx	DMX Address Setting	
	Ethernet Setup	Ethernet IP	IP Address (xxx.xxx.xxx.xxx)	Enter Fixture IP Address
			Subnet Mask (xxx.xxx.xxx.xxx)	Enter Fixture Subnet Mask Address
		Ethernet Port	Net (0-127)	Set Network
			Subnet (0-15)	Set Subnet
		Universe (0-15)	Set Universe	
	ArtNet To DMX	1. Disable 2. Enable	Enable ArtNet Protocol	
	Klingnet	1. Disable 2. Enable	Enable Klingnet Protocol	
Channel Mode		RGB, RGB16bit, RGBW , RGBW16bit, Strobe, 1, 2V, 2H, 3, 4, 4A, 6, 6A, 6H, 12, 12A, F1, F2V, F2H, F3, F4, F6V, F6H, F12	Set DMX Channel Mode	
DMX last State		Black out Hold	Function If NO DMX Detected	
White Balance		Red Green Blue	125 – 255 125 – 255 125 - 255	Calibrate White Balance
Manual Control		Red Green Blue White Intnsity Durate Rate	000 – 255 000 – 255 000 – 255 000 – 255 000 – 255 000 – 255 000 - 255	Calibrate White Balance
Auto Test			Run Auto Test Mode	
Single Flash Mode		1. Normal single flash 2. Always single flash		
Fan Mode		1. Silent Mode 2. Auto Mode 3. High Mode	Set Fan Mode	
Fixture Hours		000	Displays Total Fixture Use Hours	
Temperature		XXX F° / XXX C°	Display Fixture Internal Temperature	
USB Upgrade			Enable Service Port for Software Updates	
Software Version		A1.5 B1.5	Displays Fixture Software Version	
Factory Reset		1. No 2. Yes	Reset Fixture Settings to Factory Default	

PIXEL ZONE CONTROL

Pixel zones can be changed by selecting different Channel Modes in the system menu. See diagrams below for which pixel zone corresponds to each Channel Mode.

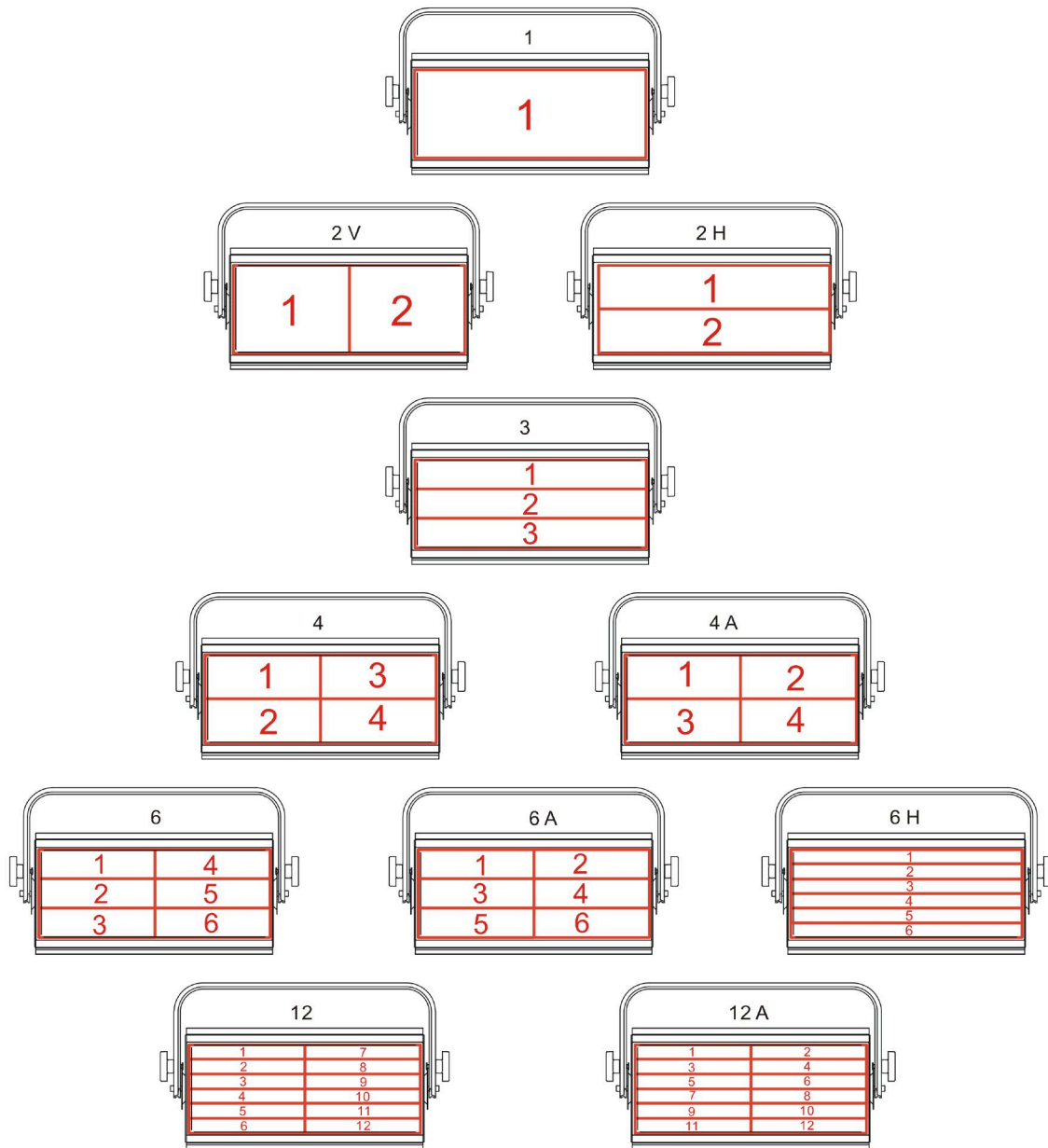

DMX CHANNEL FUNCTIONS AND VALUES

ELATION PROTRON ECLYPSE™ | DMX Channel Values / Functions (57 DMX Channels)

Supports Software Versions: ≥ 1.1

Features subject to change without any prior written notice.

*Pixel control of effects depends on DMX channel mode selected in system menu and/or orientation of fixture.

MODE / CHANNEL											VALUE	FUNCTION
RGB	RGB 16 bit	RGBW	RGBW 16 bit	Strobe	1	2	3	4	6	12		
				1	1	1	1	1	1	1	0-255	INTENSITY 0-100%
					2	2	2	2	2	2	0-255	INTENSITY FINE 16-bit FINE Adjustment
				2	3	3	3	3	3	3	0	STROBE RATE SINGLE FLASH
											0-6	OPEN
											7-255	SLOW TO FAST
				3	4	4	4	4	4	4		STROBE DURATION
											0-255	MIN TO MAX
												STROBE MODE
											0-4	STROBE
											5	WASH ALERTNATE
											6-42	RAMP UP
											43-85	RAMP DOWN
											86-128	RAMP UP - DOWN
											129-171	RANDOM
				4	5	5	5	5	5	5	172-214	LIGHTING
											215-240	SPIKES
											241-245	BURSTS
											246-248	SOLID + RND PIXEL STROBE
											249-251	BURST + RND PIXEL STROBE
												SINGLE FLASH MODE
											252-253	NORMAL SINGLE FLASH
											254-255	ALWAYS SINGLE FLASH
1	1	1	1		6	6	6	6	6	6		RED
											0-255	(0-100%)
	2		2									RED FINE
											0-255	(0-100%)
2	3	2	3		7	7	7	7	7	7		GREEN
											0-255	(0-100%)
	4		4									GREEN FINE
											0-255	(0-100%)
3	5	3	5		8	8	8	8	8	8		BLUE
											0-255	(0-100%)
	6		6									BLUE FINE
											0-255	(0-100%)
		4	7		9	9	9	9	9	9		WHITE
											0-255	(0-100%)
			8									WHITE FINE
											0-255	(0-100%)

MODE / CHANNEL											VALUE	FUNCTION
RGB	RGB 16 bit	RGBW	RGBW 16 bit	Strobe	1	2	3	4	6	12		
					10	10	10	10	10	10	0-255	RED 1 (0-100%)
					11	11	11	11	11	11	0-255	GREEN 1 (0-100%)
					12	12	12	12	12	12	0-255	BLUE 1 (0-100%)
					13	13	13	13	13	13	0-255	WHITE 1 (0-100%)
						14	14	14	14	14	0-255	RED 2 (0-100%)
						15	15	15	15	15	0-255	GREEN 2 (0-100%)
						16	16	16	16	16	0-255	BLUE 2 (0-100%)
						17	17	17	17	17	0-255	WHITE 2 (0-100%)
							18	18	18	18	0-255	RED 3 (0-100%)
							19	19	19	19	0-255	GREEN 3 (0-100%)
							20	20	20	20	0-255	BLUE 3 (0-100%)
							21	21	21	21	0-255	WHITE 3 (0-100%)
								22	22	22	0-255	RED 4 (0-100%)
								23	23	23	0-255	GREEN 4 (0-100%)
								24	24	24	0-255	BLUE 4 (0-100%)
								25	25	25	0-255	WHITE 4 (0-100%)
									26	26	0-255	RED 5 (0-100%)
									27	27	0-255	GREEN 5 (0-100%)
									28	28	0-255	BLUE 5 (0-100%)
									29	29	0-255	WHITE 5 (0-100%)
									30	30	0-255	RED 6 (0-100%)
									31	31	0-255	GREEN 6 (0-100%)
		33	33	0-255					32	32		BLUE 6 (0-100%)
											0-255	WHITE 6 (0-100%)

MODE / CHANNEL											VALUE	FUNCTION
RGB	RGB 16 bit	RGBW	RGBW 16 bit	Strobe	1	2	3	4	6	12		
											34	RED 7
											0-255	(0-100%)
											35	GREEN 7
											0-255	(0-100%)
											36	BLUE 7
											0-255	(0-100%)
											37	WHITE 7
											0-255	(0-100%)
											38	RED 8
											0-255	(0-100%)
											39	GREEN 8
											0-255	(0-100%)
											40	BLUE 8
											0-255	(0-100%)
											41	WHITE 8
											0-255	(0-100%)
											42	RED 9
											0-255	(0-100%)
											43	GREEN 9
											0-255	(0-100%)
											44	BLUE 9
											0-255	(0-100%)
											45	WHITE 9
											0-255	(0-100%)
											46	RED 10
											0-255	(0-100%)
											47	GREEN 10
											0-255	(0-100%)
											48	BLUE 10
											0-255	(0-100%)
											49	WHITE 10
											0-255	(0-100%)
											50	RED 11
											0-255	(0-100%)
											51	GREEN 11
											0-255	(0-100%)
											52	BLUE 11
											0-255	(0-100%)
											53	WHITE 11
											0-255	(0-100%)
											54	RED 12
											0-255	(0-100%)
											55	GREEN 12
											0-255	(0-100%)
											56	BLUE 12
											0-255	(0-100%)
											57	WHITE 12
											0-255	(0-100%)

S P E C I F I C A T I O N S

SOURCE

96 10W CREE RGBW 4-in-1LEDs

15,000 Hour Average LED Life*

*May vary depending on several factors including but not limited to:

Environmental Conditions, Power/Voltage, Usage Patterns (On-Off Cycling), Control, and Dimming.

EFFECTS

Color Blinder, Strobe, and Wash

Brilliant Eye Candy Effects

Selectable Pixel Mapping Control Zones

Strobe Intensity, Duration, Rate, and FX Control

Super High Speed (1-25 fps) Adjustable Strobe

8/16 Bit RGB and RGBW Smooth Color Mixing Modes

COLOR

RGBW

CONTROL / CONNECTIONS

Multiple DMX Channel Modes (24 total channels)

4 Button Control Panel with OLED Menu Display

DMX, RDM, Kling-NET, and Art-NET Protocol Support

IP65 3/5pin DMX and RJ45 Accu Ethernet Locking Data connections In/Out

IP65 Twist-Lock Power Connector In/Out

Fixture-to-Fixture Interlocking Alignment Pins/Locks

SIZE / WEIGHT

Length: 24.9" (633mm)

Width: 7.0" (177.5mm)

Vertical Height: 14.4" (364.8mm)

Weight: 34.6 lbs. (15.7 kg)

ELECTRICAL / THERMAL

AC 100-240V - 50/60Hz

843W Max Power Consumption

14°F to 113°F (-10°C to 45°C)

APPROVALS / RATINGS

CE | IP4X



Specifications and improvements in the design of this unit and this manual are subject to change without any prior written notice.

DIMENSIONAL DRAWINGS

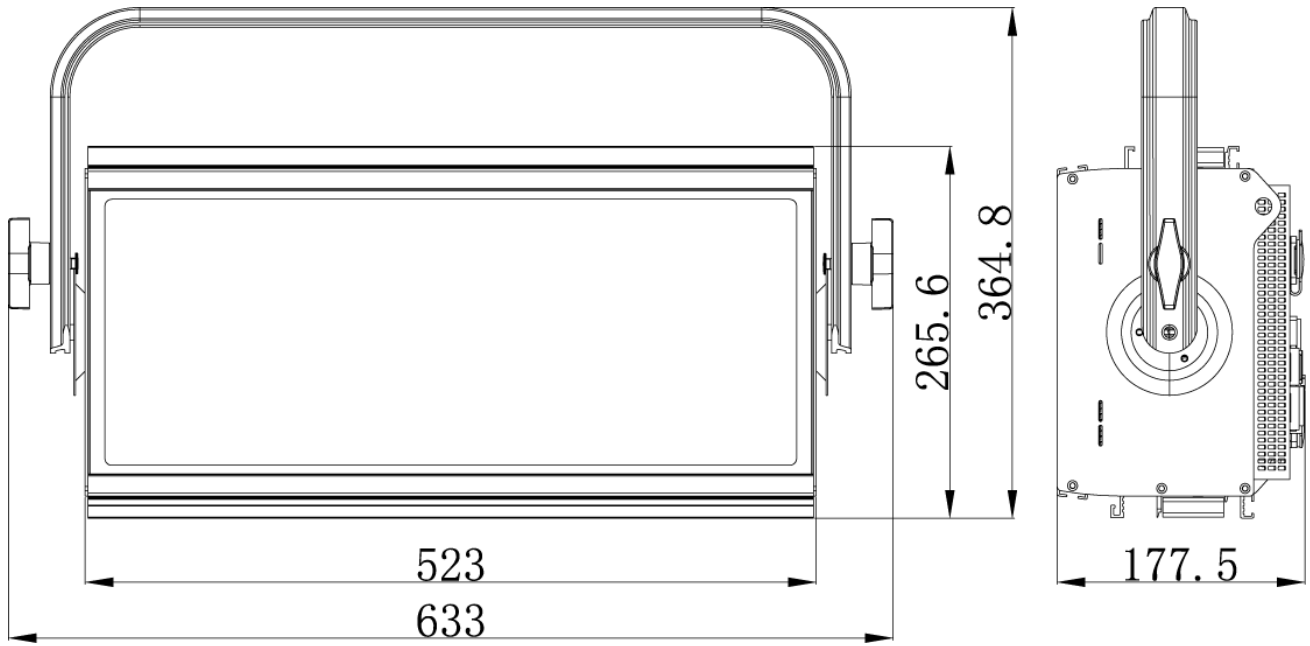

Specifications and improvements in the design of this unit and this manual are subject to change without any prior written notice.

OPTIONAL ACCESSORIES

ORDER CODE	ITEM
TRIGGER CLAMP	Heavy Duty Wrap Around Hook Style Clamp
SCABLE60	Safety Cable 24" (610mm) 60 lbs. (27kg) Rating
STR527	5 ft. (1.5m) IP65 5pin DMX Cable
NEU088	3 ft. (1m) Accu Power Locking IP Connector Power Link Cable
	Additional Cable Lengths Available

FCC STATEMENT

This device complies with Part 15 of the FCC Rules. Operation is subject to the following two conditions: (1) this device may not cause harmful interference, and (2) this device must accept any interference received, including interference that may cause undesired operation.

FCC RADIO FREQUENCY INTERFERENCE WARNINGS & INSTRUCTIONS

This product has been tested and found to comply with the limits as per Part 15 of the FCC Rules. These limits are designed to provide reasonable protection against harmful interference in a residential installation. This device uses and can radiate radio frequency energy and, if not installed and used in accordance with the included instructions, may cause harmful interference to radio communications. However, there is no guarantee that interference will not occur in a particular installation. If this device does cause harmful interference to radio or television reception, which can be determined by turning the device off and on, the user is encouraged to try to correct the interference by one or more of the following methods:

- Reorient or relocate the device.
- Increase the separation between the device and the receiver.
- Connect the device to an electrical outlet on a circuit different from which the radio receiver is connected.
- Consult the dealer or an experienced radio/TV technician for help.

Europe Energy Saving Notice

Energy Saving Matters (EuP 2009/125/EC)

Saving electric energy is a key to help protecting the environment. Please turn off all electrical products when they are not in use. To avoid power consumption in idle mode, disconnect all electrical equipment from power when not in use. Thank you.

